

F 015 942 511

Stand } 11-01-12 **Fig. /Abb. 1**
Issue }

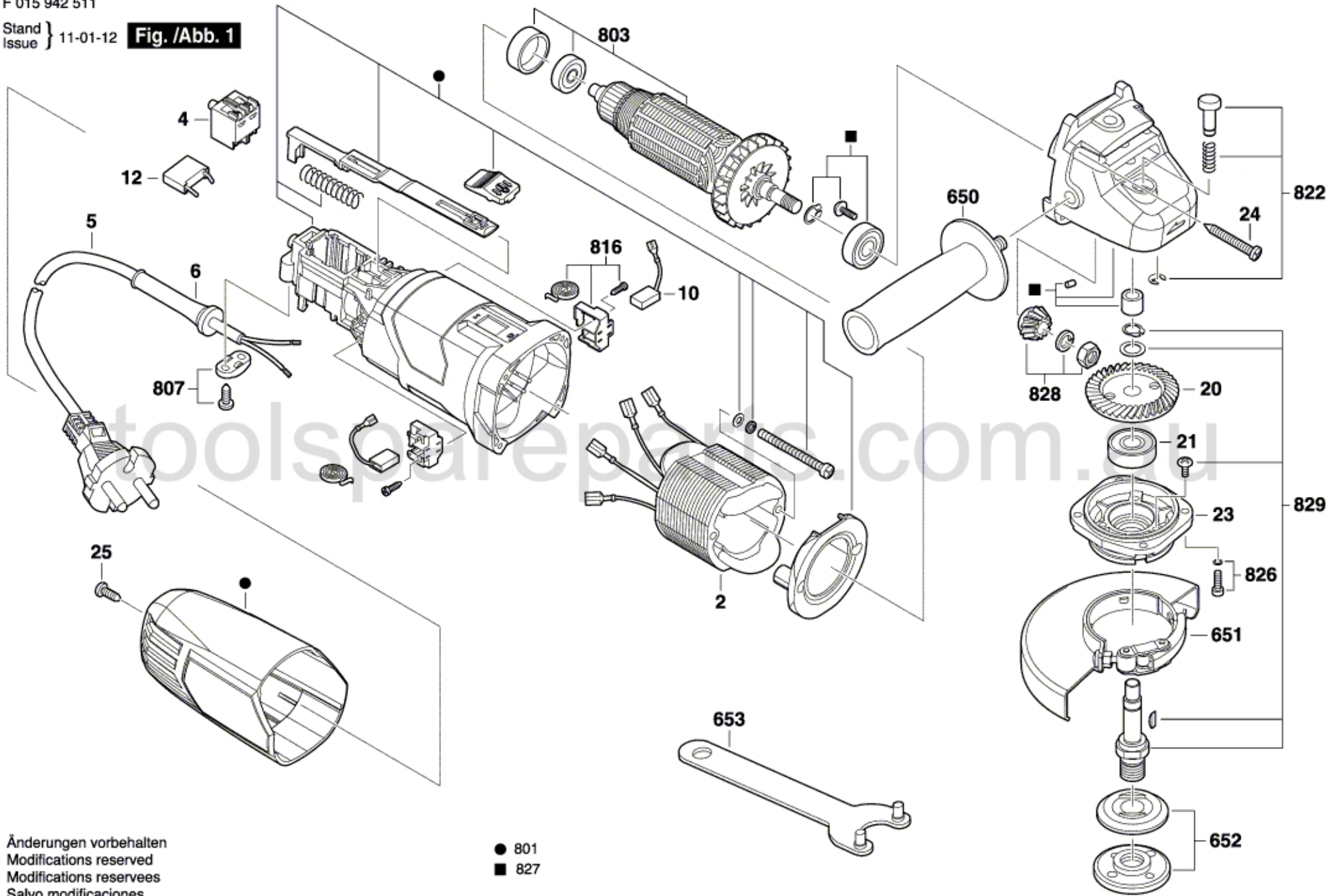

Änderungen vorbehalten
Modifications reserved
Modifications reserves
Salvo modificaciones